

**WEGO**



**WEIGAO MEDICAL INTERNATIONAL CO., LTD.**

ADD: No.1 Weigao Road,Hi-Tech Zone, Weihai, Shandong, China  
TEL: +86 631 5660699 FAX: +86 631 5622563 P.C.: 264209  
E-mail: [info@weigaogroup.com](mailto:info@weigaogroup.com) [exp@weigaogroup.com](mailto:exp@weigaogroup.com)  
Http: [//www.wegomedintl.com/](http://www.wegomedintl.com/)

This copyright belongs to Weigao Medical International Co., Ltd. Our company reserves the right to investigate legal liability in case of infringement.

2023.3 EDITION

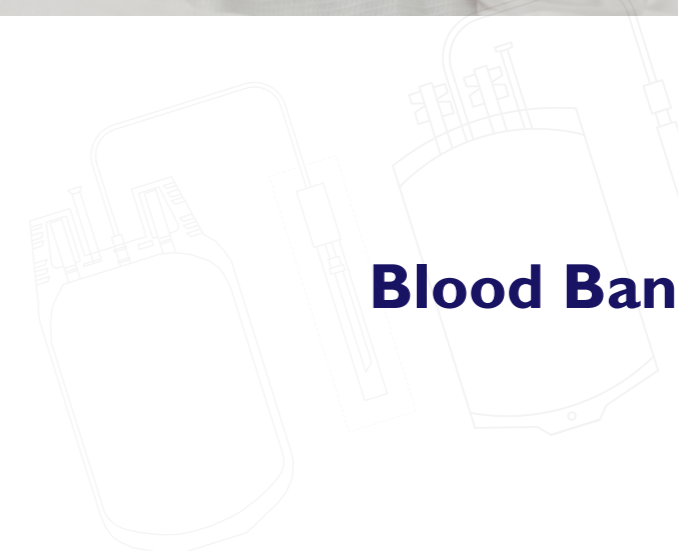

CE<sub>0123</sub>

**Blood Banking Series**



Standard Blood Bag System

### Single Blood Bag WG02-001-001

Single bag is used for collection of whole blood with anticoagulant CPDA-I solutions USP.

This Single blood bag system with a primary bag contains anticoagulant CPDA-I (citrate-phosphat-Dextrose-Adenine) which preserves red blood cells up to 35 days at 2°C-6°C.

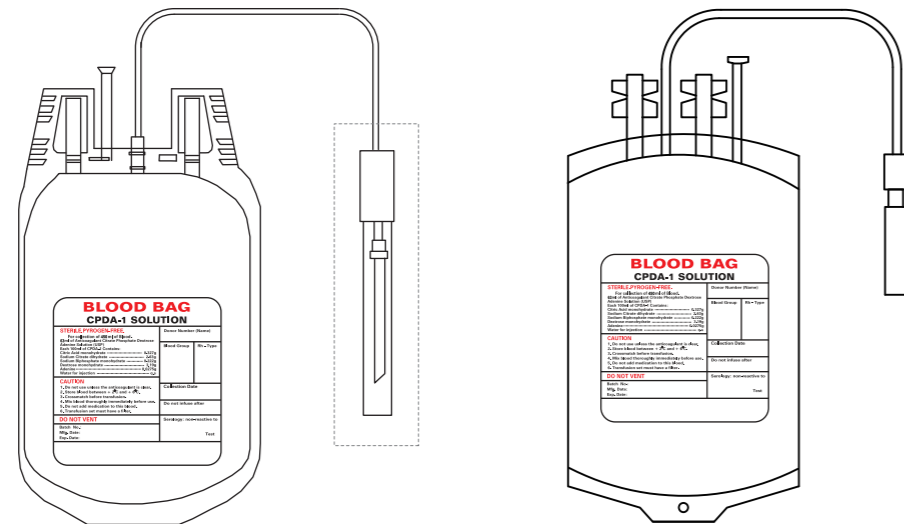

Code Number	Bag Capacity	Anticoagulant	Needle	Al foil pack /carton	
SC-100	100ml	CPDA-I	14ml	16G/17G	5/100
SC-250	250ml	CPDA-I	35ml	16G/17G	5/100
SC-350	350ml	CPDA-I	49ml	16G/17G	5/100
SC-450	450ml	CPDA-I	63ml	16G/17G	5/100
SC-500	500ml	CPDA-I	70ml	16G/17G	5/100

**Optional Features** Pre-donation sampling device, needle protective device, customized accessories  
Two options available: Welding Blood bag & Extruding Blood bag



Standard Blood Bag System

### Double Blood Bag WG02-001-002

This double blood bag system is used for separation of two components from whole blood. This double system includes one primary bag with anticoagulant CPDA-I solutions USP and one empty satellite bag.

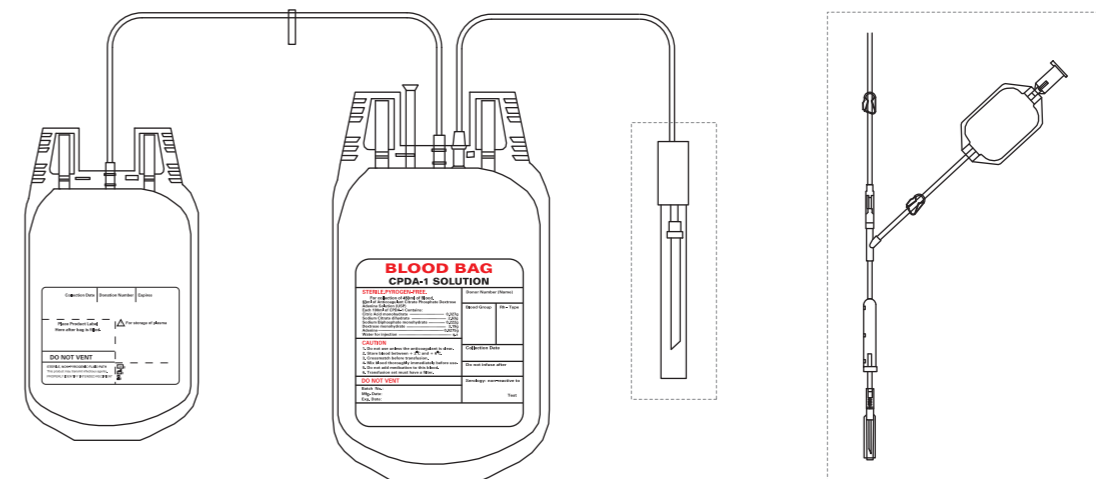

Code Number	Bag Capacity	Anticoagulant	Needle	Al foil pack /carton	Satellite
DC-250	250ml	CPDA-I	35ml	16G/17G	5/80 1X200ml
DC-350	350ml	CPDA-I	49ml	16G/17G	5/80 1X300ml
DC-450	450ml	CPDA-I	63ml	16G/17G	5/80 1X300ml
DC-500	500ml	CPDA-I	70ml	16G/17G	5/80 1X300ml

**Optional Features** Pre-donation sampling device, needle protective device, customized accessories  
Two options available: Welding Blood bag & Extruding Blood bag



### Triple Blood Bag WG02-001-003

This triple blood bag system is used for the separation of three components from whole blood. The triple system includes one primary bag with anticoagulant CPDA-I solution BP and two empty satellite bags.

The triple SAGM blood bag system includes one primary bag with anticoagulant CPD solution USP. SAGM solution in another bag and one empty satellite bag.

Standard Blood Bag System



### Quadruple Blood Bag WG02-001-004

This quadruple blood bag system is used for the separation of four components from whole human blood. The quadruple system includes one primary bag with anticoagulant CPDA-I solution USP and three empty satellite bags.

The quadruple SAGM blood bag system includes one primary bag with anticoagulant CPD solution USP, SAGM solution in another bag and two empty satellite bags.

Standard Blood Bag System

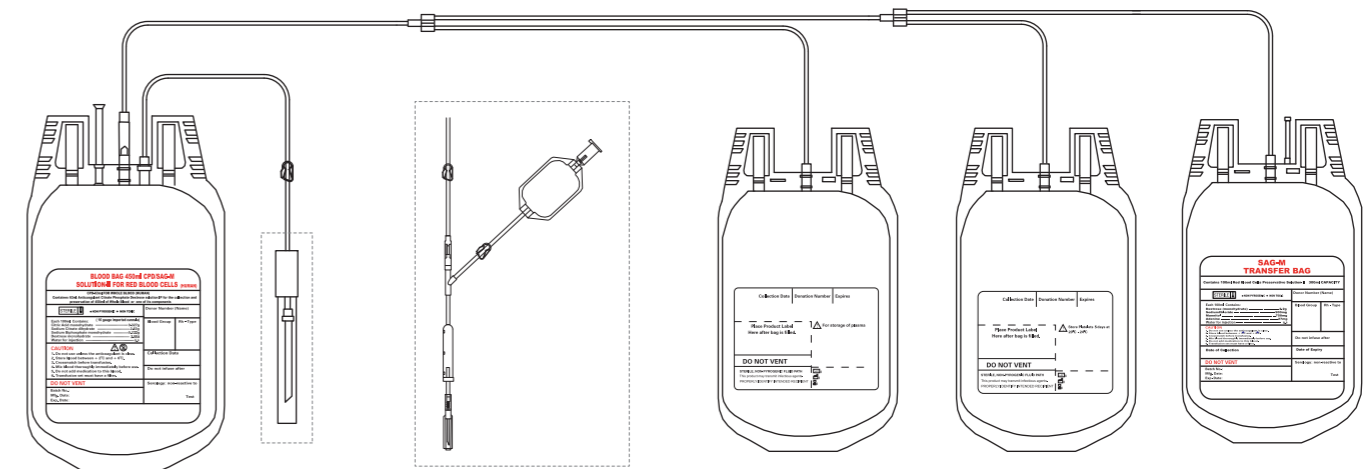
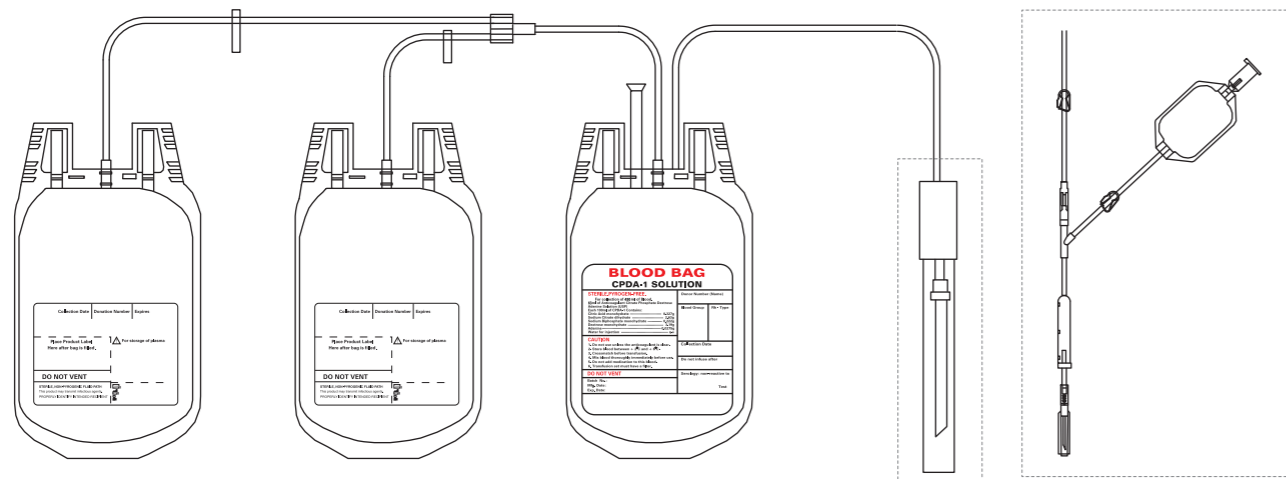

Code Number	Bag Capacity	Anticoagulant	Needle	AI foil pack /carton	Satellite	
TC-250	250ml	CPDA-I	35ml	16G/17G	2/50	2X200ml
TC-350	350ml	CPDA-I	49ml	16G/17G	2/50	2X300ml
TC-450	450ml	CPDA-I	63ml	16G/17G	2/50	2X300ml
TC-500	500ml	CPDA-I	70ml	16G/17G	2/50	2X300ml
TC-250	250ml	CPD+SAGM	35ml+56ml	16G/17G	2/50	2X300ml
TS-350	350ml	CPD+SAGM	49ml+78ml	16G/17G	2/50	2X300ml
TS-450	450ml	CPD+SAGM	63ml+100ml	16G/17G	2/50	2X300ml
TS-500	500ml	CPD+SAGM	70ml+111ml	16G/17G	2/50	2X300ml

**Optional Features** | Pre-donation sampling device, needle protective device, customized accessories  
Two options available: Welding Blood bag & Extruding Blood bag

Code Number	Bag Capacity	Anticoagulant	Needle	AI foil pack /carton	Satellite	
QC-250	250ml	CPDA-I	35ml	16G/17G	2/40	3X300ml
QC-350	350ml	CPDA-I	49ml	16G/17G	2/40	3X300ml
QC-450	450ml	CPDA-I	63ml	16G/17G	2/40	3X300ml
QC-500	500ml	CPDA-I	70ml	16G/17G	2/40	3X300ml
QS-250	250ml	CPD+SAGM	35ml+56ml	16G/17G	2/40	3X300ml
QS-350	350ml	CPD+SAGM	49ml+78ml	16G/17G	2/40	3X300ml
QS-450	450ml	CPD+SAGM	63ml+100ml	16G/17G	2/40	3X300ml
QS-500	500ml	CPD+SAGM	70ml+111ml	16G/17G	2/40	3X300ml

**Optional Features** | Pre-donation sampling device, needle protective device, customized accessories  
Two options available: Welding Blood bag & Extruding Blood bag





## Quadruple Blood Bag (Top & Bottom)

WG02-001-005

The quadruple top and bottom CPD-SAGM blood bag system includes one primary bag with anticoagulant CPD solution USP, one bag with anticoagulant SAGM solution in another bag and two empty satellite bags.

Standard Blood Bag System

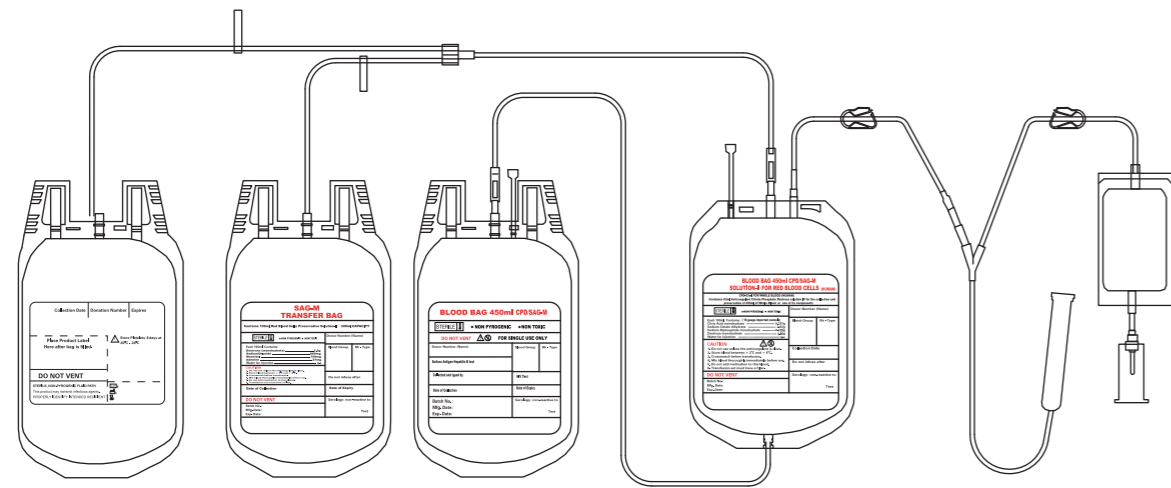

Code Number	Bag Capacity	Anticoagulant	Needle	AI foil pack /carton	Satellite
QS-450	450ml	CPD+SAGM 63ml+100ml	16G/17G	2/40	3X300ml
QS-500	500ml	CPD+SAGM 70ml+111ml	16G/17G	2/40	3X300ml

**Optional Features** | Pre-donation sampling device, needle protective device, customized accessories  
Two options available: Welding Blood bag & Extruding Blood bag



## Quadruple Blood Bag With Leukocyte Filter

WG02-001-006

This quadruple blood bag system for human blood and its components with solutions of anticoagulant CPD and preservative SAGM, with filter, single use, sterile.

Standard Blood Bag System

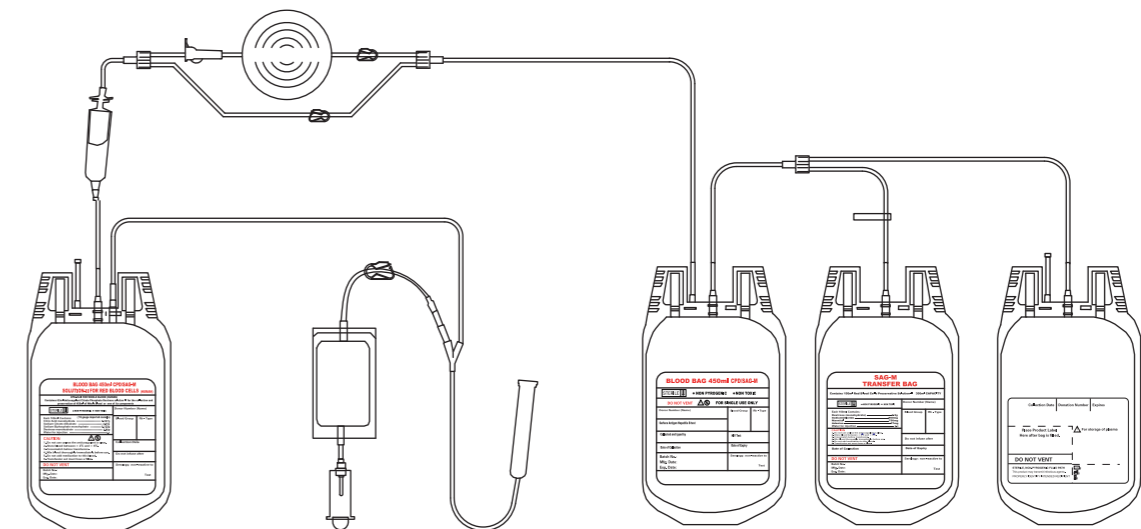

Code Number	Bag Capacity	Anticoagulant	Needle	AI foil pack /carton	Satellite
QC-250	250ml	CPDA-I 35ml	16G/17G	2/40	3X200ml
QC-350	350ml	CPDA-I 49ml	16G/17G	2/40	3X400ml
QC-450	450ml	CPDA-I 63ml	16G/17G	2/40	3X400ml
QC-500	500ml	CPDA-I 70ml	16G/17G	2/40	3X200ml
QS-250	250ml	CPD+SAGM 35ml+56ml	16G/17G	2/40	3X400ml
QS-350	350ml	CPD+SAGM 49ml+78ml	16G/17G	2/40	3X400ml
QS-450	450ml	CPD+SAGM 63ml+100ml	16G/17G	2/40	3X400ml
QS-500	500ml	CPD+SAGM 70ml+111ml	16G/17G	2/40	3X400ml

**Optional Features** | Pre-donation sampling device, needle protective device, customized accessories  
Two options available: Welding Blood bag & Extruding Blood bag



## WG02-001-007 Platelet Carrier

1. Temperature control with digital display: constant temperature 22 °C, accuracy within 1 °C.
2. Both AC 220V and DC 12V are available.
3. Semiconductor cooling provides a two-way prolonged 22 °C despite the hot or freezing ambient temperature.
4. High efficiency, ambient temperature 10-35 °C constant temperature to 22 °C, cooling time is less than 30 minutes.
5. Temperature change does not exceed 2 degrees in 15 minutes after a power failure.

Wattage 40W

Voltage AC 220V/50Hz; DC 12V

Ambient temperature 10-35 °C

Internal temperature 22±2 °C

Oscillation range 50mm

Oscillation frequency 60 times/min

Size 18L: external 410x300x410mm (LxWxH), 4 bags of 400mL blood

45L: external 600x400x475mm (LxWxH), 10 bags of 400mL blood



## WG02-001-008 Cryoprecipitation plasma preparation instrument

1. Space-saving exterior shape, easy to place against the wall and side-by-side.
2. Applicable functions for timer setting and the inner water tank can be pre-cooled in advance.
3. Prepare by batch or individually.  
Batch preparation operates efficiently with unified installation and preparation. Single preparation operates freely. Move blood bags at any time without interference between workstations.
4. Good insulation and a relatively closed and clean environment shorten the pre-cooling time to save more power.
5. Convenient operation only starts with installing the blood bag. Lift the transfer bag after the preparation to automatically open the tube clamp, making it easy to remove the blood bag.
6. Indicators show preparation status (idle, in preparation, abnormal alarm, preparation complete).
7. The weighing plate and scanner are designed in the middle of the equipment for easy preparation.
8. Record function connects with the blood station system with code scanning to save, export, or upload the data.



## WG02-001-009 High-efficiency transistor tube sealer

### Internal Structure

Human-centered design with user-friendly interface.  
Excellent cooling system ensure the machine can work continuously.  
Safe, reliable, and lifelong transistor control and power output.  
High intelligence automatically adjusts the heat power according to the different thicknesses of the tubing.  
Heat-proof thermal sealing electrode avoids the occurrence of hemolysis.  
Compound filter shielding design with strong electromagnetic compatibility prevents surrounding instruments from interfering.

1. high degree of intelligence automatically adjusts the heat laminating power according to the different thicknesses of the tubing and also can adjust the width of the heating surface according to special circumstances.
2. Safe, reliable, and lifelong transistor control and power output.
3. Environmental-friendly materials and an excellent cooling system ensure the machine can work continuously.
4. Heat-proof thermal sealing electrode avoids the occurrence of hemolysis.
5. Transparent retractable splash-protection sheet protects the operator's safety.
6. Disassembled and cleanable protective cap of the healer's head.
7. Compound filter shielding design with strong electromagnetic compatibility prevents surrounding instruments from interfering.
8. Working status indicator and abnormal condition warning available.
9. Light-weighted and easy to use.

Ambient temperature: 0 C -40 C  
Relative humidity: ≤80%  
Atmospheric pressure: 70kPa-106kPa  
Power supply: 220V±22V 50Hz±1Hz  
RF frequency: ≤40.68MHz  
RF power: ≥30W  
Power consumption: work ≤ 250W standby ≤ 5W  
Sealing time: 0.5-3S  
Diameter of tubing: 2-6mm  
External size: 248mm\*156mm\*144mm  
Weight: 6.0Kg±0.5Kg



**Ambient temperature**  
15-35°C

**Relative humidity**  
20%-50%

**Operating room temperature**  
2-8°C



## WG02-001-010 Low-temperature operating cabinet

The low-temperature cabinet can ensure the operating room temperature stays at 2-8 C under 15-35 C ambient temperature and 20-50% relative humidity. The product provides an excellent operating environment for leukocyte filtering.  
Scope of application: preparation room of all kinds of blood stations.

1. Automatic air curtain operates smoothly with low noise and high cooling efficiency.
2. Adopting R134a refrigerant, the refrigeration effect is stable and does not destroy the ozone layer, which is conducive to environmental protection.
3. Adopt a microcomputer temperature controller and American Dallas integrated sensor, which can realize intelligent control and one key on/off.
4. Adopt high-quality stainless steel plate to do the work surface, satisfactory quality, beautiful and generous appearance.

External size 198cm (L) × 75.5cm (D) × 187cm (H)  
Overall wattage 2000W  
Power supply 220V 50Hz  
Internal size 190cm (L) × 54cm (D) × 128cm (H)  
Temperature cooling down to set temperature in 30 minutes  
Weight 400Kg (including condensing unit)



# WG02-001-01 I

## Blood Balancing Instrument

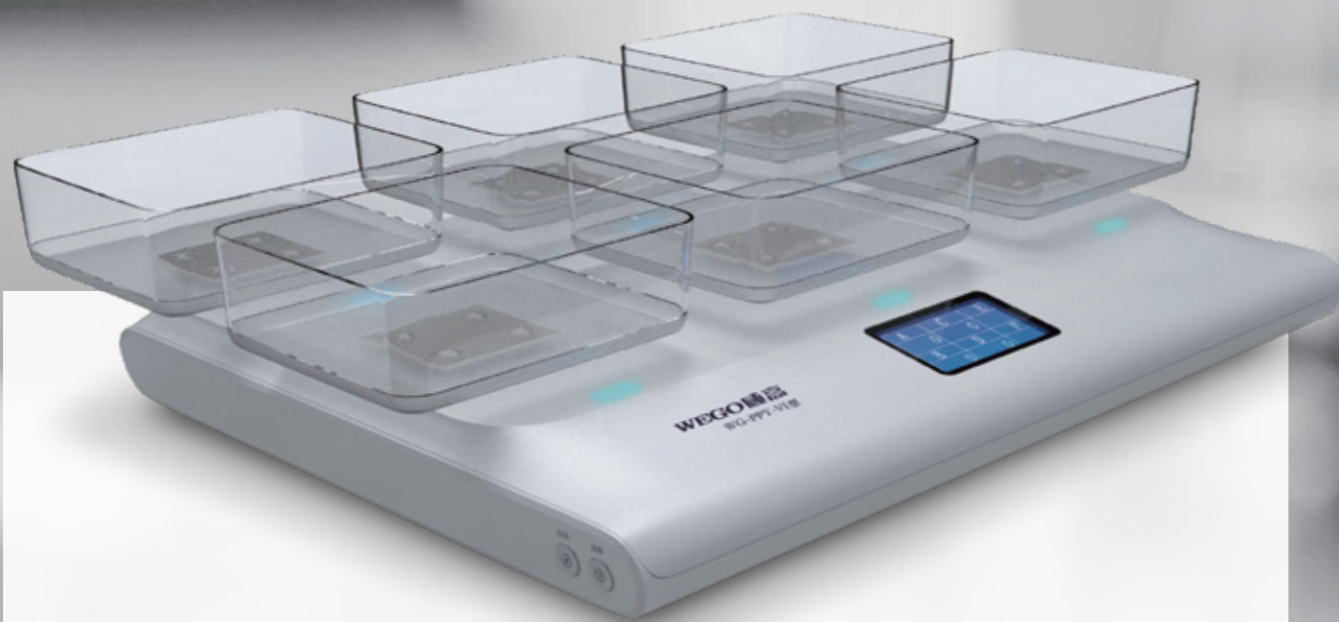

LED display



Easy operation



High precision

Microcomputer leveling instrument (leveling instrument) is an ideal instrument for leveling the weight of blood bags before centrifugation, developed to improve the quality and efficiency of blood preparation. The use of this equipment can improve the quality of blood component collection.

01

Adopt microcomputer processing technology, program memory, high accuracy, single tray weighing error  $\leq 3$  g.



02

LCD screen can show the weight of each tray, tip the closest weight (indicator blinks).

650

03

Adopt a three-color indicator, clear and easy to operate.



04

Stabilization time was reduced to 2.5 seconds, shorter, faster, and more stable.



25 s

05

Parameters are self-calibrated to avoid errors caused by different gravity in different areas. Single plate weighing 5000g.



06

Adaptable to higher temperatures up to 35°C.



35°C

07

Classic tricolor light and improved design make it easier to observe and operate.



08

The single tray weighing error is reduced from 0.8‰ to 0.6‰.





WG02-001-012

## Low-Temperature Operation Desk

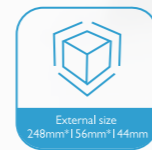
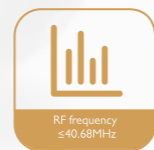
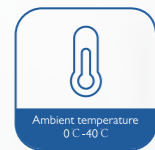

### Low-temperature operating desk

The low-temperature desk can ensure the operating room temperature stays at 2-8 °C under 15-35 °C ambient temperature and 20-50% relative humidity. The product is an ideal instrument for preparing, labeling, sorting, packing, and choosing blood components.

Scope of application: preparation room of all kinds of blood stations.

- 1) Smooth operation, low noise, high efficiency and stable cooling.
- 2) R134a refrigerant does not destroy the ozone layer, which is conducive to environmental protection.
- 3) Adopt a microcomputer temperature controller and American Dallas integrated sensor, which can realize intelligent control and one key on/off.
- 4) Adopt high-quality stainless steel plate to do the work surface, satisfactory quality, beautiful and generous appearance.

Surface temperature: 2-8 °C  
External size: 200 cm(L) X 100 cm(D) X 80 cm(H)  
Wattage: 2000 w  
Temperature cooling down to 2 °C in 30 minutes  
Weight: 150 kg(condenser included)

